

CM-300, CM-300 FD CM-300 FI, CM-300 R

Instruction Book



Lacunza congratulates you on your choice.
Certified under ISO 9001, Lacunza guarantees the quality of its appliances and undertakes to meet the needs of its customers.
Confident of the know-how afforded by more than 50 years' experience, Lacunza uses advanced technologies in the design and manufacture of its entire range of appliances. This document will help you install and use your appliance in optimum conditions for your comfort and safety.

CONTENTS

1. PRESENTATION OF THE APPLIANCE	3
1.1. General characteristics.....	3
2. INSTRUCTIONS FOR THE INSTALLER	6
2.1. Warning to installers.....	6
2.2. Room for installation.....	6
2.2.1. Ventilation of the room.....	6
2.2.2. Location of the appliance in the room	7
2.3. Installation of the appliance.....	7
2.3.1. Floor.....	7
2.3.2. Safety distances.....	7
2.3.3. Checks before lighting for the first time.....	7
2.3.4. Height adjustment and levelling the appliance	8
2.3.5. Placement tubes covers and top finish.....	8
2.3.6. Connection to the flue.....	9
2.4. Chimney flue	9
2.4.1. Type of flue	9
2.4.2. Chimney crown	10
3. INSTRUCTIONS OF USE.....	12
3.1. Fuel.....	12
3.2. Description of the parts of the appliance.....	13
3.2.1. Operating components	13
3.3. Lighting.....	14
3.4. Safety	14
3.5. Loading fuel.....	14
3.6. Operation	14
3.7. Removing ash.....	15
3.8. Deflectors. Flapper valve.....	15
4. MAINTENANCE AND IMPORTANT ADVICE.....	16
4.1. Maintenance of the appliance	16
4.1.1. Firebox	16
4.1.2. Inside the appliance	16



4.1.3. Flue socket	16
4.1.4. Painted sheet-steel-cast-iron parts.	16
4.1.5. Firebox glass.....	16
4.2. Maintenance of the chimney flue	16
4.3. Important advice.....	16
5. TROUBLESHOOTING.....	17
6. DECLARATION OF PERFORMANCE	18
7. CE MARK	22

1. PRESENTATION OF THE APPLIANCE

For optimum operation of the appliance, we advise you to read this manual carefully before switching on the appliance for the first time. In case of problems or concerns, we urge you to contact your dealer, who will cooperate with you.

In order to improve the product, the manufacturer reserves the right to make changes without notice by updating this document.

This appliance is designed to burn wood in absolutely safe conditions.

WARNING: Faulty installation may have serious consequences.

Installation and all necessary regular maintenance operations must be performed by an authorized installer in full accordance with the specifications set out in the legislation applicable in each country and this instruction book.

1.1. General characteristics

	Unit	CM-300	CM-300 FD	CM-300 FI	CM-300 R
Nominal Heat Output (N.H.O.) to atmosphere	kW	10.53	11	11	10.5
Efficiency at N.H.O.	%	80	79	79	74
CO emission at 13% O ₂ at N.H.O.	%	0.37	0.33	0.33	0.31
Gas mass flow at N.H.O.	g/s	9	10	10	11
Gas temperature of flue at N.H.O.	°C	229	230	230	286
Optimum flue draught	Pa	12	12	12	12
Wood consumption (beech) at N.H.O.	Kg/h	2.6	2.8	2.8	2.8
Dimensions of the firebox					
Width	mm	660	640	640	730
Depth	mm	410	410	410	444
Useful height	mm	390	390	390	390
Maximum length of the logs	cm	60	60	60	60
Volume heated (45w/m ³) at N.H.O.	m ³	233	244	244	233
Log load frequency	h	1	1	1	1
Capacity of the ashpit	L	3.2	3.2	3.2	2.6
Weight	kg	175	175	175	190
Flue socket diameter	mm	200	200	200	200
Energy efficiency class	-	A+	A+	A+	A+
Energy efficiency index (EEI)	-	107	107	107	107

Note: The values indicated in the above table are based on tests performed in accordance with UNE-EN 13240 with logs with no more than 18% humidity and pressure conditions as indicated in each case.

Warning: this appliance is designed and prepared to work with the types of fuel, degree of humidity of the fuel, fuel loads, fuel load frequencies, flue draught and system of installation indicated in this Instruction Book. Failure to respect these conditions may lead to problems with the appliance (deterioration, shorter useful life, etc.) which are not covered by the Lacunza warranty.

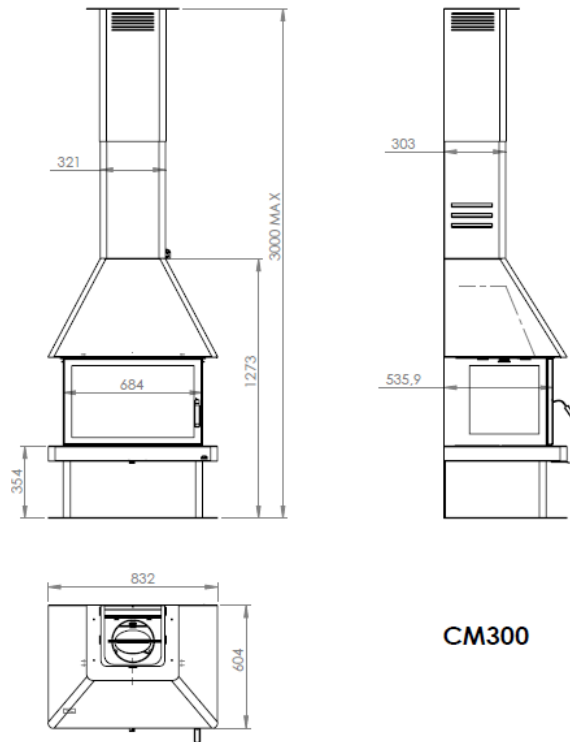
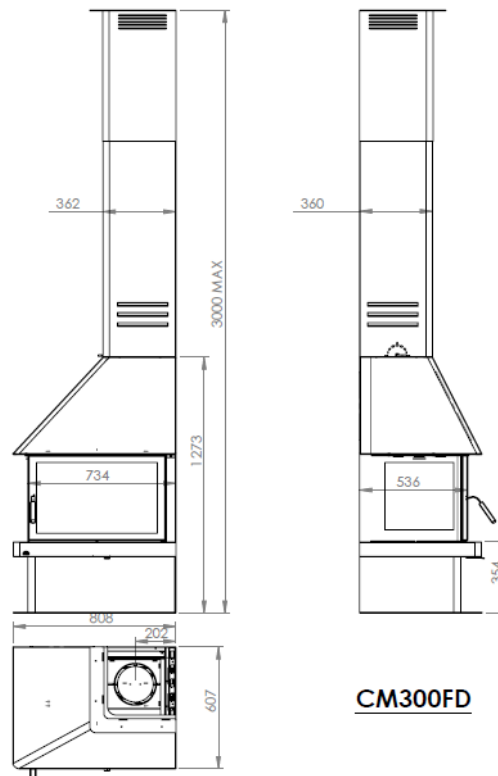
CM300
Figure No.1 - Dimensions of the CM-300 appliance in mm

CM300FD
Figure No.2 - Dimensions of the CM-300 FD appliance in mm

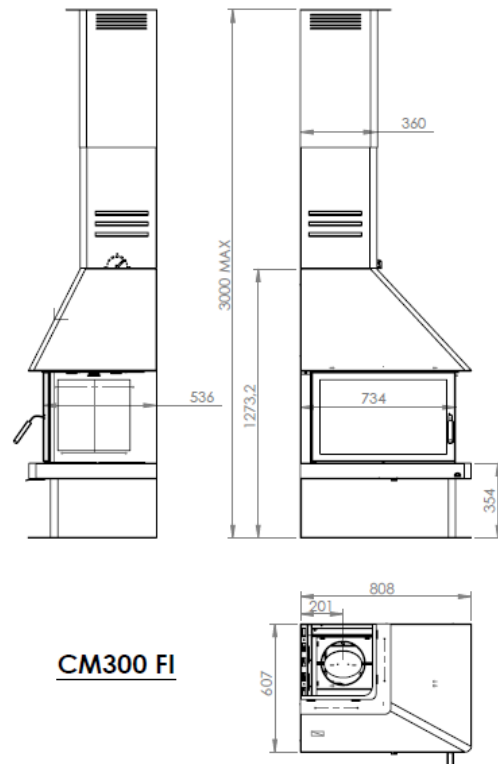

Figure No.3 - Dimensions of the CM-300 FD appliance in mm

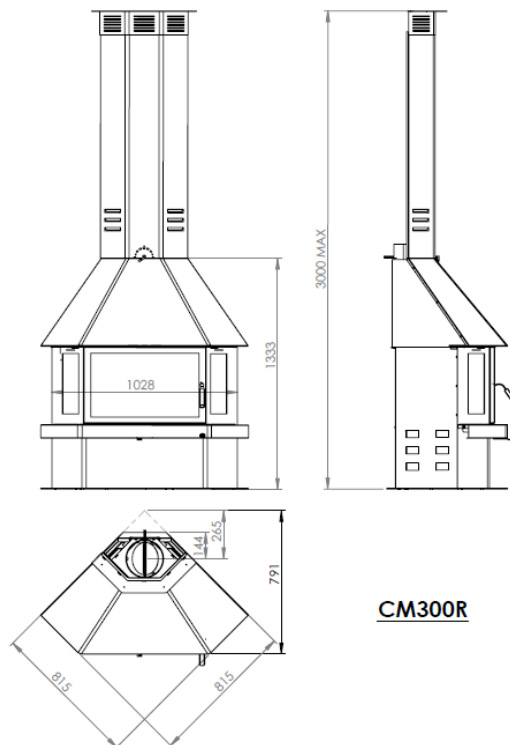

Figure No.4 - Dimensions of the CM-300 R appliance in mm

2. INSTRUCTIONS FOR THE INSTALLER

2.1. Warning to installers

All local and national regulations, including all those referring to national and European standards, must be observed when installing the appliance.

Installation of the appliance must be performed by an authorised installer.

An incorrectly installed appliance may lead to serious incidents (fires, creation of harmful gases, deterioration of nearby fixtures, etc.).

Lacunza's liability is limited to the supply of the material and does not include installation of the appliance.

2.2. Room for installation

2.2.1. Ventilation of the room

The appliance needs to consume oxygen (air) in order to work properly. Ensure a suitable air supply in the room in which the appliance is fitted. This quantity of oxygen is additional to the oxygen that we need in order to breathe (air renewal).

In order to ensure the high quality of the air you breathe and to avoid potential accidents resulting from high concentrations of the gases produced by combustion (mainly carbon dioxide and carbon monoxide), it is absolutely crucial to ensure the suitable renewal of the air in the room in which the appliance is fitted.

the room must always have at least two permanent grilles or openings to the exterior in order to renew the air (one for intake and the other for extraction).

For the installation of its appliances, Lacunza recommends an additional section for these openings. One of these two grilles must be situated high up in the room (at

less than 30 cm from the ceiling) and the other one low down (at less than 30 cm from the floor). Both grilles must open outdoors in order to renew the air in the room with fresh air.

The minimum section that each of these grilles must have depends on the nominal output of the appliance in accordance with the following table:

Output of the appliance (kW)	Minimum additional section of each of the grilles (cm ²)
$P \leq 10\text{kW}$	70
$10 < P \leq 15$	90
$15 < P \leq 20$	120
$20 < P \leq 25$	150
$25 < P \leq 30$	180
$30 < P \leq 35$	210
$P > 35$	240

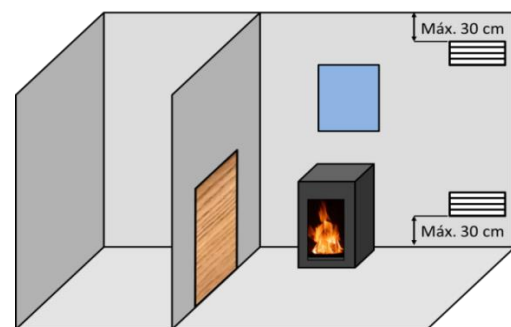

Figure No.5 - Guideline indications for ventilation grilles

The appliance must always be used with the door(s) closed.

In rooms equipped with Controlled Mechanical Ventilation, the system extracts and renews the ambient air; in such cases, the room is at slightly low pressure and it is necessary to install a non-closable outside-air inlet with a section of at least 90 cm².

2.2.2. Location of the appliance in the room

Choose a location in the room which favours good hot-air distribution by convection and radiation.

2.3. Installation of the appliance

2.3.1. Floor

Make sure that the base can withstand the total constructed weight of the appliance and its casing.

The apparatus should not be placed on combustible material.

2.3.2. Safety distances

Be sure to respect the appliance installation distances from **combustible materials**. Looking at the appliance head-on:

CM 300	Distance to combustible materials (mm)
From the right-hand side	900
From the left-hand side	900
From the rear	400
From the front	1000

CM 300 FD	Distancia a materiales combustibles (mm)
Desde el costado derecho	400
Desde el costado izquierdo	900
Desde la trasera	400
Desde el frente	1000

CM 300 FI	Distancia a materiales combustibles (mm)
Desde el costado derecho	900
Desde el costado izquierdo	400
Desde la trasera	400
Desde el frente	1000

CM 300 R	Distancia a materiales combustibles (mm)
Desde el costado derecho	200
Desde el costado izquierdo	200
Desde el frente	1000

Bear in mind that it may even be necessary to protect non-combustible material in order to prevent breakage, deformation, etc., as a result of overheating if the non-combustible material is not designed to withstand high temperatures.

2.3.3. Checks before lighting for the first time

- Make sure that the glass/es is/are not broken or damaged.
- Make sure that the flueway is not obstructed with packing or loose parts.
- Check the deflectors are correctly positioned.
- Make sure that the airtight joints on the flue circuit are in perfect condition.
- Make sure that the doors close properly.
- Make sure that all moving parts are fitted in place.

2.3.4. Height adjustment and levelling the appliance

The appliance must be perfectly level, horizontally and vertically, both at the front and on the sides (use a spirit level).

2.3.5. Placement tubes covers and top finish

The chimney is equipped with a tube cover and an upper finish to make the connection with the ceiling (maximum height 3 meters).

Once the stove is placed in its location and the flue pipe has been connected, we will install the tube cover.

1º If the ceiling height is between 2.5m and 3m, the two whole pieces are placed, but if the ceiling height we have is between 2.3m and 2.5m, the lower part of the tube cover must be cut by the half-cut marks.

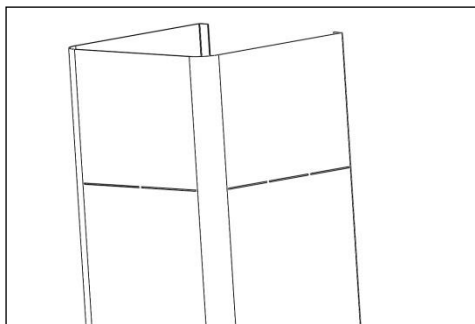

Figure No.6 - Half-cut marks of the lower tube cover

Place the handle of the draught damper flapper valve in a vertical position and fit the bottom of the tube cover, inserting the 4 screws that the tube cover brings, into the bell holes.

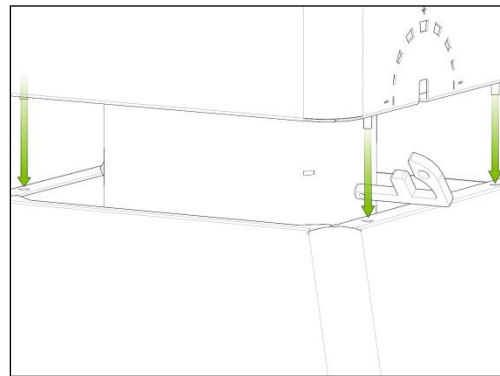

Figure No.7 - Lower tube cover positioning

3.- Position the upper part of the tube cover and after marking on the ceiling, place 4 anchoring plugs. Then we hold this piece to the ceiling with 4 screws.

IMPORTANT:

The ceiling has to support the weight of the upper tube cover, if the ceiling is not able to support it, place it in such a way that all the weight does not fall on the ceiling, such as screwing the two parts of the tube cover together so that everything weight does not fall on the ceiling.

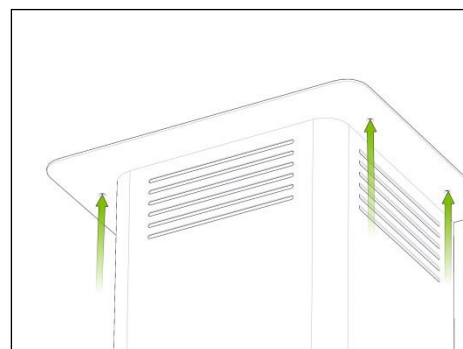

Figure No.8 - Screw the upper tube cover to the ceiling

VERY IMPORTANT: Do not cover the grilles of the the upper part of the tube cover; if necessary, cut the lower part of the tube cover

so that when overlapping those hot air extraction holes are not closed.

2.3.6. Connection to the flue

The appliance must be connected to the chimney flue using special piping designed to resist the products of combustion (e.g. stainless steel, enamelled steel, etc.).

To connect the flue to the socket flange, insert the piping inside the flange and seal the joint with fire sealant or fire cement to make it completely airtight.

The installer must ensure that the pipe connected to the appliance is well secured and there is no chance of it coming free from its housing (e.g. as a result of dilatation due to temperature, etc.).

On this appliance, the flue socket can be fitted either on top or at the rear of the appliance.

2.4. Chimney flue

The chimney flue must comply with present standards on the installation of chimneys.

In rooms equipped with Controlled Mechanical Ventilation, the ventilation outlet must never be connected to the flue.

The appliance must always have its own chimney flue, never sharing a chimney flue with another appliance.

2.4.1. Type of flue

The flue must be made of special material designed to resist the products of combustion (e.g. stainless steel, enamelled steel, etc.).

Non-central-heating appliances (without back boiler) require an insulated, double-sleeve flue only on those sections that run outdoors or through cold areas. Single piping can be used inside the building, the heat of the gases serving to

heat rooms, insulating only those sections where excess temperature may cause damage.

If the chimney is constructed, then it is necessary to pipe and insulate it to ensure correct updraught.

The diameter of the pipe must be the same as the diameter of the flue socket on the appliance over its entire length in order to ensure correct operation.

The flue must prevent the entry of rainwater.

The flue must be clean and airtight over its entire length.

The flue must be at least 6m tall and the chimney cap must not hinder the free release of gases.

If the flue tends to suffer from downdraught, then it is necessary to fit an effective anti-downdraught cowl, a static cowl or a smoke extraction fan, or reshape the chimney.

Never make 90° bends, due to the great loss of draught they cause, and reduce 45° bends down to an absolute minimum. Each 45° bend is equivalent to a 0.5m reduction in flue length. Horizontal flue sections should not be installed because they cut updraught a great deal.

If the flue draws at more than 20 Pa on 12Pa, then an effective damper must be fitted on the flueway. This damper must be visible and accessible.

The chimney flue must not rest on the appliance.

Bear in mind that high temperatures may be reached in the flue, meaning that it is essential that insulation be enhanced in sections in which combustible material is present (wooden beams, furniture, etc.). It may even be necessary to protect non-combustible material in order to prevent breakage, deformation, etc., as a result of

overheating if the material is not designed to withstand high temperatures.

It must be possible to clean the entire flue, no sections being left inaccessible for cleaning purposes.

2.4.2. Chimney crown

The upper end of the chimney must clear the roof, the roof ridge or any obstacle located on the roof by at least 1m.

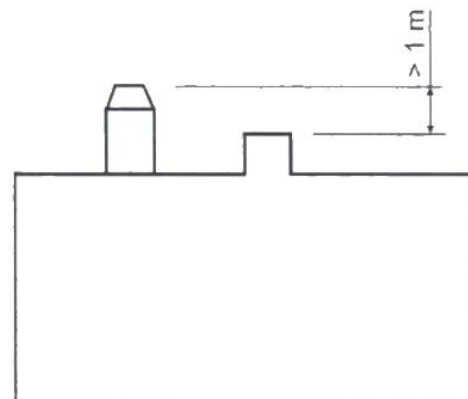
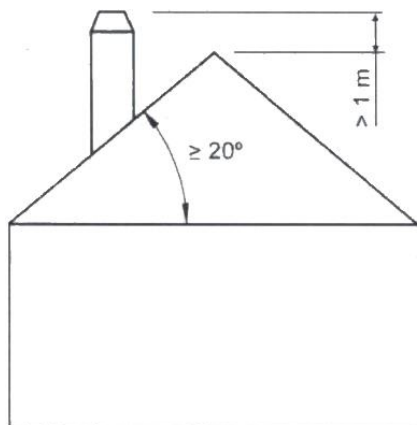
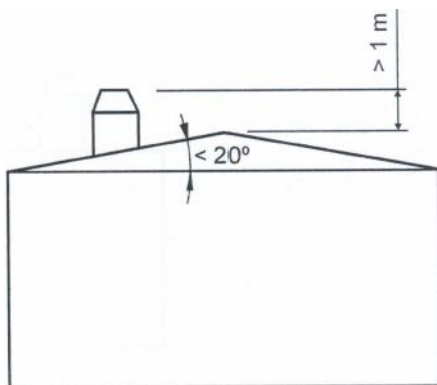

Figure No.9 - Distances between chimney crown and roof ridge

The chimney crown must clear the highest point of any neighbouring building or obstacle located within a 10m radius of the chimney outlet by more than 1m.

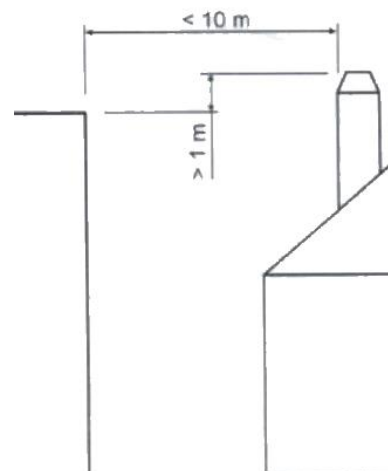

Figure No.10 - Distances between the chimney crown and objects within a 10m radius

The chimney crown must clear any neighbouring building or obstacle located within a radius of 10m to 20m from the chimney outlet.

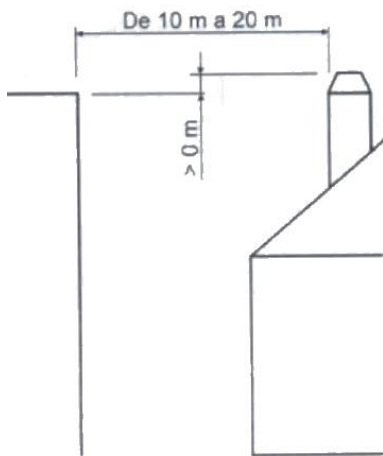

Figure No.11 - Distances between the chimney crown and objects within a radius of between 10 and 20m

3. INSTRUCTIONS OF USE

The manufacturer accepts no liability whatsoever for damage caused to parts as a result of the improper use of non-recommended fuels, modifications made to the appliance or how it is installed.
Only use original replacement parts.

All local and national regulations, including those referring to national and European standards, must be observed when using the appliance.

Heat is diffused by radiation and convection via the front and exterior of the appliance.

3.1. Fuel

This appliance must not be used as an incinerator. Do not use non-recommended fuels.

- Use dry logs (max. 16% humidity), cut at least 2 years ago, clean of resin and stored in a sheltered, ventilated place.
- Use hard woods with high calorie values and good ember production.
- Large logs should be cut to useable lengths before being stored. The logs should have a maximum diameter of 150mm.
- Finely-chopped wood produces greater heat output, but also burns more quickly.

Optimum fuels:

- Beech.

Other fuels:

- Oak, chestnut, ash, maple, birch, elm, etc.
- Pine and eucalyptus logs are low density and produce very long flames, and may cause the parts of the appliance to wear out more quickly than normal.

- Resinous wood may mean that the appliance and the flue need to be cleaned more often.

Non-permitted fuels:

- All types of coal and liquid fuel.
- “Green wood”. Green or damp wood reduces the performance of the appliance and leads to soot and tar build-up on the inner walls of the flue, obstructing it.
- “Recovered wood”. The burning of treated woods (railway sleepers, telegraph posts, plywood, fibreboard, pallets, etc.) quickly blocks the system (soot and tar build-up), harms the environment (pollution, smells) and may lead to deformation of the firebox due to overheating.
- All materials which are not wood (plastic, spray cans, etc.).

Green and reprocessed wood may cause chimney fires.

The graph below shows how the humidity of firewood affects its heat output:

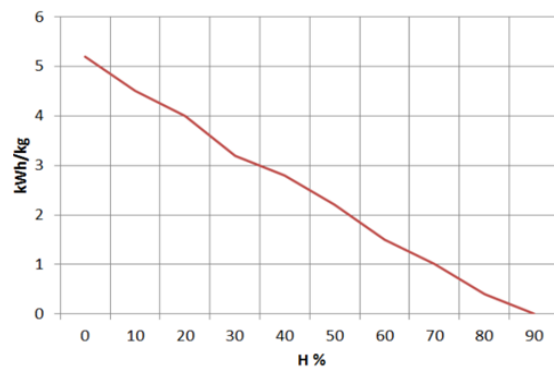

Figure No.12 - Relationship between firewood humidity and heat output.

3.2. Description of the parts of the appliance

3.2.1. Operating components

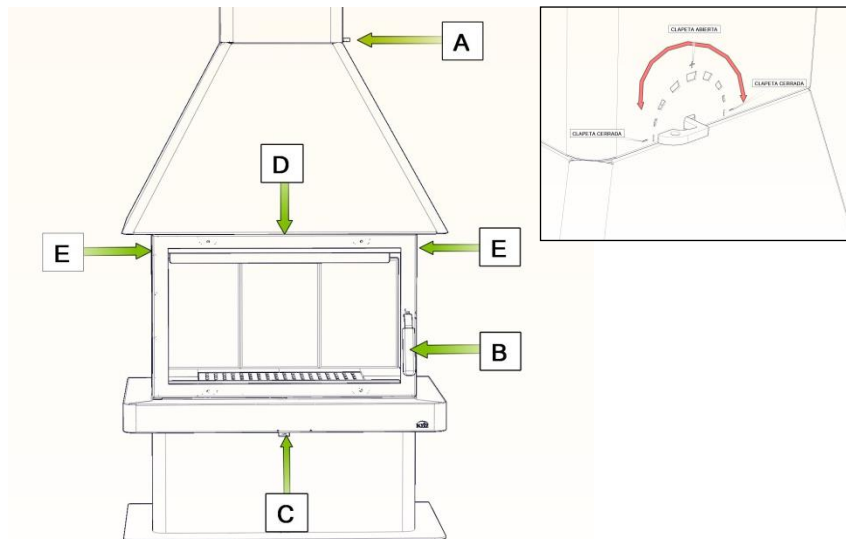

Figure No.13 - Operating components on the appliance

- A: Draught damper flapper valve
- B: Firebox door handle
- C: Primary air intake
 - C1 open (right)
 - C2 closed (left)
- D: Door secondary air intake
 - D1 open (right)
 - D2 closed (left)
- E: Lateral secondary air intake
 - E1 open (right)
 - E2 closed (left)

3.3. Lighting

Use of the appliance in warm weather (warm days, early hours of the afternoon on sunny days) may lead to lighting and updraught problems.

Certain weather conditions, such as fog, ice, humidity entering the flue, etc., may hinder sufficient updraught in the flue and lead to suffocation.

Proceed as follows in order to light the appliance satisfactorily:

- Open the firebox door(s) and open all the firebox air-intake inlets to the full.
- Place paper or a firelighter and some wood chips in the firebox.
- Light the paper or firelighter.
- Leave the door slightly ajar, the width of two or three fingers, for about 15 minutes until the glass warms up.
- The first time the appliance is lit, the fire should be gentle to allow the parts of the appliance to dilate and dry.

Important: The first time it is lit up, the appliance may give off smoke and strange smells. This is not a cause for concern. Open an outdoor window to ventilate the room during the first few hours of operation.

If you notice water around the appliance, this is produced by the condensation of the moisture in the wood on lighting the fire. This condensation will no longer appear when the appliance has been lit three or four times and has adapted to its flue. If it does not disappear, then check the flue draught (length and diameter of the flue, flue insulation, airtightness) and the humidity of the wood used.

3.4. Safety

Do not store combustible materials beneath the appliance.

3.5. Loading fuel

In order to load firewood, open the firebox door gently, preventing the sudden entry of air to the firebox so that smoke does not enter the room that the appliance is installed in.

Perform this operation with the glove to prevent burns to the hands.

The maximum load height is 2 logs with diameters of approx. 10 cm.

The minimum interval between loads for nominal heat output is 60 minutes.

Always load with the nominal amount (see table in section 1.1).

For minimum burning (e.g. at night), use thicker logs.

When the firebox is loaded, close the door.

Be careful when placing logs in the firebox on appliances with refractories interiors. Refractory is a fragile material and may crack if knocked.

3.6. Operation

The appliance should be operated with the door closed.

For safety reasons, never close all the appliance's combustion-air intakes.

Primary-air intake

By opening this inlet, air enters the firebox via the firebox grille.

Secondary-air intake

By opening this inlet, air enters the firebox via the top of the firebox door.

IMPORTANT: Keeping the secondary-air intake open helps keep the door glass cleaner for longer.

IMPORTANT: The appliance is exposed to extreme changes in temperature and may, as a result, make noises when in operation. These noises are a natural result of expansion/contraction of the parts which make up the appliance. Do not be alarmed by noises of this kind.

In order to obtain maximum output, open all the air intakes to the firebox and in order to obtain minimum output, tend towards closing them. For normal use, we recommend you close the Primary Intake and leave the Secondary Intakes open.

3.7. Removing ash

Following sustained use of the appliance, it is necessary to remove the ash from the firebox. Remove the ashpit box when cold or using something to prevent yourself from getting burned (glove).

Never throw hot embers into the rubbish.

Access the ashpit by opening the door on the appliance.

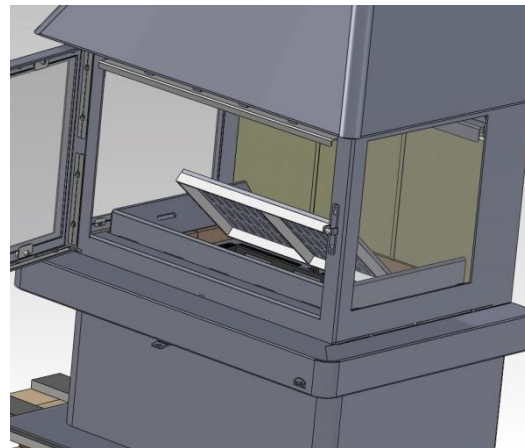

Figure No.14 - Access the ashpit by opening the door on the appliance

Warning! It is very important to put the ashpit back in its housing at the bottom of the firebox after emptying it of ashes and before lighting the fire again! Do this by following the extraction process in reverse order.

3.8. Deflectors. Flapper valve

The appliance has an updraught-regulating flapper valve on the flue socket. This can be used to modify the section through which the gases pass and, consequently, control the updraught.

The CM-300, CM-300 FD and CM-300 FI appliances have 1 deflector.

The CM-300 R appliance has 2 deflectors.

4. MAINTENANCE AND IMPORTANT ADVICE

4.1. Maintenance of the appliance

The appliance, the flue connector piping and the flue must be cleaned regularly, particularly following long periods without use.

4.1.1. Firebox

Clean the firebox area of ash, etc.

4.1.2. Inside the appliance

The inside of the firebox can also be accessed from the bottom by extracting-pushing up the cast-iron grille and removing the ashpit. Clean the area of ash through the hollow left after removal (use a vacuum cleaner if necessary).

Clean the firebox area of ash. Clean the deflectors, where soot may build up.

4.1.3. Flue socket

The flue socket area must be kept clean at all times for the appliance to work properly.

It must be cleaned as often as required. How often it is cleaned depends on how much the appliance is used and the type of fuel employed.

4.1.4. Painted sheet-steel-cast-iron parts.

These parts should be cleaned with a brush or dry cloth. Do not dampen the parts: the steel could rust and the paint could blister and chip. Be particularly careful when cleaning the glass: the liquids used must not dampen the painted steel.

4.1.5. Firebox glass

Keep the secondary-air intake open to keep the door glass cleaner for longer.

However, the glass may get dirty the longer the appliance is used. Special degreasing products designed for the purpose should be used to clean it.

Clean when the glass is cold and taking care not to apply the glass cleaner directly onto the glass as it could come into contact with the door-seal cord and damage it.

4.2. Maintenance of the chimney flue

VERY IMPORTANT: In order to avoid incidents (chimney fires, etc.), it is necessary to perform maintenance and cleaning operations on a regular basis; if the appliance is used often, then the chimney and the flue connector piping must be swept several times a year.

In the event of fire in the chimney, close the flue draught, close doors and windows, remove embers from the firebox, block the connection hole with damp cloths and call the fire brigade.

4.3. Important advice

Lacunza recommends that only Lacunza-authorized replacement parts be used.

Lacunza accepts no liability for any modification to the product which it has not authorised.





This appliance is a heat-producing appliance and contact may lead to burns.

This appliance may remain HOT for a period of time after it has gone out. **MAKE SURE THAT SMALL CHILDREN DO NOT GO NEAR IT.**

5. TROUBLESHOOTING



This symbol means that a qualified professional should be called to perform the operation.

Problem	Probable causes		Solution
The fire does not light properly The fire does not stay alight	Green or damp wood		Use hard woods, cut at least 2 years ago and stored in a sheltered, ventilated place
	The logs are too large		Use crumpled paper or firelighters and dry wood chips to light the fire. Use split logs to keep the fire going
	Poor-quality wood		Use hard woods which produce heat and embers (chestnut, ash, maple, birch, elm, beech, etc.)
	Insufficient primary air		Open the primary- and secondary-air intakes completely, or even open the door slightly. Open the outdoor-air inlet grille
	Insufficient updraught		Check that the draught is not blocked. De-soot if necessary. Check that the flue is in perfect condition (airtight, insulated, dry, etc.)
The fire flames up too much	Excessive primary air		Close the primary- and secondary-air intakes partially or totally
	Excessive updraught		Install a draught damper
Smoke given off on lighting	Poor-quality wood		Do not continually burn chips, carpentry scraps (plywood, pallets, etc.)
	Cold flue		Heat up the flue by burning a piece of paper in the firebox.
Smoke during burning	The room is at low pressure		In rooms with Controlled Mechanical Ventilation, leave an outdoor window ajar until the fire is fully alight.
	Too little wood loaded		Load as recommended. Loads notably smaller than those recommended lead to low smoke temperature and downdraught.
	Insufficient updraught		Check the condition of the flue and insulation. Check that the piping is not blocked. Clean mechanically if necessary
	Wind enters the flue		Install an anti-downdraught system (Cowl) at the top of the chimney
Does not warm up enough	The room is at low pressure		In rooms with Controlled Mechanical Ventilation, there must be an outdoor-air inlet
	Poor-quality wood		Only use the recommended fuel
Water condenses (after the appliance has been lit more than 3 or 4 times)	Too little wood loaded		Load as recommended. Loads notably smaller than those recommended lead to low smoke temperature and condensation.
	Green or damp wood		Use hard woods, cut at least 2 years ago and stored in a sheltered, ventilated place.
	Condition of the flue		Lengthen the flue (5-6 metres minimum). Insulate the flue properly. Check the airtightness of the flue/appliance.

6. DECLARATION OF PERFORMANCE



ES-5-010

DECLARACIÓN DE PRESTACIONES Conforme al R. E. Productos Construcción (UE) N° 305/2011

DÉCLARATION DE PERFORMANCE Selon le Règlement (UE) N° 305/2011

DICHIARAZIONE DI PRESTAZIONE In base al Regolamento (UE) N° 305/2011

DECLARATION OF PERFORMANCE According to Regulation (UE) N° 305/2011

DECLARAÇÃO DE PRESTAÇÕES Em base com o Regulamento (UE) N° 305/2011

- Nombre y/o código de identificación única del producto:
Nom-code d'identification unique du produit
Nome-codice identificativo unico del prodotto
Unique identifier nome-code for product
Nome-código de identificação único do produto
 - Marca, marque, marca, mark, marca: Lacunza
 - Tipo, type, tipo, type, tipo: Estufa, Poêle, Stufa, Stove, Aquecedor
 - Modelo, modèle, modello, model, modelo: **CM-300**
- Uso o usos previstos del producto: Estufa de carga manual, para quemar combustibles sólidos (indicado en instrucciones), cuya función es calentar el espacio en el que está instalada.
Utilisation prévue du produit: Poêle qui se charge manuellement, conçu pour brûler des combustibles solides (indiqués dans le Manuel d'Instructions), dont la fonction est de chauffer l'espace où il est installé.
Usi previsti del prodotto: Stufa a carico manuale, per bruciare combustibili solidi (indicati nelle istruzioni), la cui funzione è riscaldare lo spazio in cui è installato.
Entended uses of the product: Stove to be loaded by hand and designed to burn solid fuels (indicated in instructions), whose function is to heat the space in which it is installed.
Utilização prevista do produto: Aquecedor de carga manual, para queimar combustíveis sólidos (indicado nas instruções), cuja função é aquecer o espaço no qual está instalado.
- Nombre y dirección del fabricante: **LACUNZA KALOR GROUP S.A.L.**
Nom et adresse du fabricant: **Pol. Ind. Ibarrea s/n 31800 Alsasua (Navarra) (España)**
Nome e indirizzo del fabbricante: **Téléfono: (0034) 948563511**
Name and adress of the manufacturer: **Fax: (0034) 948563505**
Nome e endereço do fabricante: **Email: comercial@lacunza.net**
- Sistema de evaluación y verificación de la constancia de las prestaciones: 3
Système d'évaluation et contrôle de la constante de performance: 3
Sistema di valutazione e verifica della costanza della prestazione: 3
Assessment and verification system for constancy of performance: 3
Sistema de avaliação e verificação da regularidade do desempenho: 3
- Organismo Notificado, Laboratoire notifié, Laboratorio notificato, Laboratory notified, Laboratório notificado:
CEIS N° NB1722 Centro de ensayos, innovación y servicios
Cr. Villaviciosa de Odón a Mostoles (M-856)
Km 1.5 Mostoles 28935
Por el sistema, Selon le system, In base al system, Based on system, Em base ao system : 3.
Documento emitido (fecha), Numéro du rapport d'essai (date), Numero rapporto di prova (data), Test report number (date), Número relação de prova (data): **LEE/014/11 (06-05-2011)**



ES-5-010

DECLARACIÓN DE PRESTACIONES Conforme al R. E. Productos Construcción (UE) N° 305/2011**DÉCLARATION DE PERFORMANCE** Selon le Règlement (UE) N° 305/2011**DICHIARAZIONE DI PRESTAZIONE** In base al Regolamento (UE) N° 305/2011**DECLARATION OF PERFORMANCE** According to Regulation (UE) N° 305/2011**DECLARAÇÃO DE PRESTAÇÕES** Em base com o Regulamento (UE) N° 305/2011

- Nombre y/o código de identificación única del producto:
Nom-code d'identification unique du produit
Nome-codice identificativo unico del prodotto
Unique identifier nome-code for product
Nome-código de identificação único do produto
 - Marca, marque, marca, mark, marca: Lacunza
 - Tipo, type, tipo, type, tipo: Estufa, Poêle, Stufa, Stove, Aquecedor
 - Modelo, modèle, modello, model, modelo: **CM-300**
- Uso o usos previstos del producto: Estufa de carga manual, para quemar combustibles sólidos (indicado en instrucciones), cuya función es calentar el espacio en el que está instalada.
Utilisation prévue du produit: Poêle qui se charge manuellement, conçu pour brûler des combustibles solides (indiqués dans le Manuel d'Instructions), dont la fonction est de chauffer l'espace où il est installé.
Usi previsti del prodotto: Stufa a carico manuale, per bruciare combustibili solidi (indicati nelle istruzioni), la cui funzione è riscaldare lo spazio in cui è installato.
Entended uses of the product: Stove to be loaded by hand and designed to burn solid fuels (indicated in instructions), whose function is to heat the space in which it is installed.
Utilização prevista do produto: Aquecedor de carga manual, para queimar combustíveis sólidos (indicado nas instruções), cuja função é aquecer o espaço no qual está instalado.
- Nombre y dirección del fabricante: **LACUNZA KALOR GROUP S.A.L.**
Nom et adresse du fabricant: **Po. Ind. Ibarrea s/n 31800 Alsasua (Navarra) (España)**
Nome e indirizzo del fabbricante: **Téléfono: (0034) 948563511**
Name and adress of the manufacturer: **Fax: (0034) 948563505**
Nome e endereço do fabricante: **Email: comercial@lacunza.net**
- Sistema de evaluación y verificación de la constancia de las prestaciones: 3
Système d'évaluation et contrôle de la constante de performance: 3
Sistema di valutazione e verifica della costanza della prestazione: 3
Assessment and verification system for constancy of performance: 3
Sistema de avaliação e verificação da regularidade do desempenho: 3
- Organismo Notificado, Laboratoire notifié, Laboratorio notificato, Laboratory notified, Laboratório notificado: **CEIS N° NB1722 Centro de ensayos, innovación y servicios**
Cr. Villaviciosa de Odón a Mostoles (M-856)
Km 1.5 Móstoles 28935
Por el sistema, Selon le system, In base al system, Based on system, Em base ao system : 3.
Documento emitido (fecha), Numéro du rapport d'essai (date), Numero rapporto di prova (data), Test report number (date), Número relação de prova (data): **LEE/014/11 (06-05-2011)**



ES-S-012

DECLARACIÓN DE PRESTACIONES Conforme al R. E. Productos Construcción (UE) Nº 305/2011**DÉCLARATION DE PERFORMANCE** Selon le Règlement (UE) N° 305/2011**DICHIARAZIONE DI PRESTAZIONE** In base al Regolamento (UE) N° 305/2011**DECLARATION OF PERFORMANCE** According to Regulation (UE) N° 305/2011**DECLARAÇÃO DE PRESTAÇÕES** Em base com o Regulamento (UE) N° 305/2011

- Nombre y/o código de identificación única del producto:
Nom-code d'identification unique du produit
Nome-codice identificativo unico del prodotto
Unique identifier nome-code for product
Nome-código de identificação único do produto
 - Marca, marque, marca, mark, marca: LACUNZA
 - Tipo, type, tipo, type, tipo: Estufa, Poêle, Stufa, Stove, Aquecedor
 - Modelo, modèle, modello, model, modelo: **CM-300FI y CM-300FD**
- Uso o usos previstos del producto: Estufa de carga manual, para quemar combustibles sólidos (indicado en instrucciones), cuya función es calentar el espacio en el que está instalada.
Utilisation prévue du produit: Poêle qui se charge manuellement, conçu pour brûler des combustibles solides (indiqués dans le Manuel d'Instructions), dont la fonction est de chauffer l'espace où il est installé.
Usi previsti del prodotto: Stufa a carico manuale, per bruciare combustibili solidi (indicati nelle istruzioni), la cui funzione è riscaldare lo spazio in cui è installato.
Intended uses of the product: Stove to be loaded by hand and designed to burn solid fuels (indicated in instructions), whose function is to heat the space in which it is installed.
Utilização prevista do produto: Aquecedor de carga manual, para queimar combustíveis sólidos (indicado nas instruções), cuja função é aquecer o espaço no qual está instalado.
- Nombre y dirección del fabricante: **LACUNZA KALOR GROUP S.A.L.**
Nom et adresse du fabricant: **Pol. Ind. Ibarrea s/n 31800 Alsasua (Navarra) (España)**
Nome e indirizzo del fabbricante: **Téléfono: (0034) 948563511**
Name and address of the manufacturer: **Fax: (0034) 948563505**
Nome e endereço do fabricante: **Email: comercial@lacunza.net**
- Sistema de evaluación y verificación de la constancia de las prestaciones: 3
Système d'évaluation et contrôle de la constante de performance: 3
Sistema di valutazione e verifica della costanza della prestazione: 3
Assessment and verification system for constancy of performance: 3
Sistema de avaliação e verificação da regularidade do desempenho: 3
- Organismo Notificado, Laboratoire notifié, Laboratorio notificato, Laboratory notified, Laboratório notificado: **CEIS Nº NB1722 Centro de ensayos, innovación y servicios**
Cr. Villaviciosa de Odón a Mostoles (M-856)
Km 1.5 Mostoles 28935
Por el sistema, Selon le system, In base al system, Based on system, Em base ao system : 3.
Documento emitido (fecha), Numéro du rapport d'essai (date), Numero rapporto di prova (data), Test report number (date), Número relação de prova (data): **LEE/015/11 (13-05-2011)**

6. Prestaciones declaradas, Performance déclarée, Prestazioni dichiarate, Services declare, Desempenhos declarados:

Especificaciones técnicas armonizadas, Spécifications techniques armonices, Specifica tecnica armonizzata, Harmonised technical specifications, Especifica técnica harmonizada EN13240:2001/A2:2004/AC:2006/AC:2007	
Características esenciales, Caractéristiques essentielles, Caratteristiche essenziali, Essential features, Características essenciais	Prestaciones, Performance, Prestazione, Services, Desempenho
Reacción al fuego, Resistance au feu, Resistenza al fuoco, Resistance to fire, Resistência ao fogo	Cumple, Conforme, Conforme, Compliant, Em Conformidade
Distancia mínima de seguridad a materiales combustibles, Distance minimum aux matériaux combustibles, Distanza minima da materiali combustibili, Minimum distance from combustible material, Distância mínimo de materiais combustíveis	Izquierda, gauche, sinistra, left, esquerda: 200-900mm Derecha, droite, diritto, right, direito: 200-900mm Trasera, arrière, retro, back, traseira: 400mm Delantera, avant, fronte, front, frente: 1000mm Encimera, dessus, sopra, above, acima: 750mm
Temperatura humos a potencia térmica nominal, Température des fumées, Temperatura fumi, Fume temperatura, Temperatura dos gases de combustão	230 °C
Emisión de productos de combustión, Emission des produits de combustion, Emission prodotti combustione, Combustión productos emissions, Emissões de produtos de combustão	Cumple, Conforme, Conforme, Compliant, Em Conformidade
Concentración media CO al 13% O2	0.33 %
Desprendimiento de sustancias peligrosas	Cumple, Conforme, Conforme, Compliant, Em Conformidade
Temperatura superficial, Température de surface, Temperatura superficiale, Surface temperatura, Temperatura superficial	Cumple, Conforme, Conforme, Compliant, Em Conformidade
Seguridad eléctrica, Sécurité électrique, Sicurezza elettrica, Electrical safety, Segurança elétrica	-
Presión máxima de servicio (paila), Pression maximale de service, Máxima pressione di esercizio, Maximum operating pressure, Máxima pressão de exercício	-
Resistencia mecánica (para soportar una chimenea/un conducto de humos), Résistance mécanique (pour soutenir la cheminée), Resistenza mecánica (per supportare il camino), Mechanical strength (to support the fireplace), Resistência mecânica (para suportar a chaminé)	Cumple, Conforme, Conforme, Compliant, Em Conformidade
Potencia térmica ambiente, Puissance rendue au milieu, Potenza resa all'ambiente, Power output to the environment, Potência libertada no ambiente	10.8 kW
Potencia térmica agua, Puissance rendue à l'eau, Potenza ceduta all'acqua, Power transferred to water, Potência cedida à água	-
Rendimiento energético, Rendement, Rendimento, Efficiency, Atuação	79.3 %

Las prestaciones del producto identificado en el punto 1 son conformes con las prestaciones declaradas en el punto 6.
 La performance du produit cité au point 1 est conforme à la performance declare au point 6.
 La prestazione del prodotto di cui al punto 1 è conforme alla prestazione dichiarata di cui al punto 6.
 The performance of the product referred to in point 1 is consistent with the declared performance in point 6.
 As declarações do produto identificado no ponto 1, estão conformes com as prestações declaradas no ponto 6.

La presente declaración de prestaciones se emite bajo la única responsabilidad del fabricante, indicado en el punto 3.
 Cette déclaration de performance est délivrée sous la responsabilité exclusive du fabricant cité au point 3.
 Si rilascia la presente dichiarazione di prestazione sotto la responsabilità esclusiva del fabricante di cui al punto 3.
 This declaration of performance is issued under the manufacturer's sole responsibility referred to in point 3.
 É emitida a presente declaração de desempenho sob a responsabilidade exclusiva do fabricante referido no ponto 3.





Lacunza Kalsi Group S.A.
 NIF A-3106542
 Polígono Industrial Ibañeta s/n
 48100 Alsasua (Navarra) Spain

José Julián Garcandía Pellejero
 Director Gerente

Alsasua 01-07-2013

7. CE MARK

 11	LACUNZA KALOR GROUP S.A.L. Pol. Ind. Ibarrea s/n 31800 Alsasua (Navarra) (Spain)
	Número, Nombre, Numero, Number, Número : ES-S-010
Marca, marque, marca, mark, marca: Lacunza Tipo, type, tipo, type, tipo: Estufa, Poêle, Stufa, Stove, Aquecedor Modelo, modèle, modello, model, modelo: CM-300	Organismo notificado, Laboratoire notifié, Laboratorio notificato, Laboratory notified, Laboratorio notificado: CEIS N° NB1722
Estufa de carga manual, para quemar combustibles sólidos (indicado en instrucciones), cuya función es calentar el espacio en el que está instalada. Poêle qui se charge manuellement, conçu pour brûler des combustibles solides (indiqués dans le Manuel d'Instructions), dont la fonction est de chauffer l'espace où il est installé. Stufa a carico manuale, per bruciare combustibili solidi (indicati nelle istruzioni), la cui funzione è riscaldare lo spazio in cui è installato. Stove to be loaded by hand and designed to burn solid fuels (indicated in instructions), whose function is to heat the space in which it is installed. Aquecedor de carga manual, para queimar combustíveis sólidos (indicado nas instruções), cuja função é aquecer o espaço no qual está instalado.	
EN13240:2001/A2:2004/AC:2006/AC:2007	
Características esenciales, Caractéristiques essentielles, Caratteristiche essenziali, Essential features, Características essenciais	Prestaciones, Performance, Prestazione, Services, Desempenho
Reacción al fuego, Resistance au feu, Resistencia al fuoco, Resistence to fire, Resistência ao fogo	Cumple, Conforme, Conforme, Compliant, Em Conformidade
Distancia mínima de seguridad a materiales combustibles, Distance minimum aux matériaux combustibles, Distanza minima da materiali combustibili, Minimum distance from combustible material, Distância mínimo de materiais combustíveis	Izquierda, gauche, sinistra, left, esquerda: 900mm Derecha, droite, diritto, right, direito: 900mm Trasera, arrière, retro, back, traseira: 400mm Delantera, avant, fronte, front, frente: 1000mm Encimera, dessus, sopra, above, acima: 750mm
Temperatura humos a potencia térmica nominal, Température des fumées, Temperatura fumi, Fume temperatura, Temperatura dos gases de combustão	229 °C
Emisión productos combustión, Emisión des produits de combustion, Emisión prodotti combustione, Combustión productos emissions, Emissões de produtos de combustão	Cumple, Conforme, Conforme, Compliant, Em Conformidade
Concentración media CO al 13% O2, Concentration moyenne CO al 13% O2, CO concentrazione media di O2%, Average concentration CO to O2%, CO concentração média de O2%	0.37 %
Desprendimiento de sustancias peligrosas, Rejet de substances dangereuses, Rilascio di sostanze pericolose, Release of hazardous substances, Lançamento de substâncias perigosas	Cumple, Conforme, Conforme, Compliant, Em Conformidade
Temperatura superficial, Température de surface, Temperatura superficiale, Surface temperatura, Temperatura superficial	Cumple, Conforme, Conforme, Compliant, Em Conformidade
Seguridad eléctrica, Sécurité électrique, Sicurezza elettrica, Electrical safety, Segurança elétrica	-
Presión máxima de servicio (palla), Pression maximale de service, Máxima pressione di esercizio, Maximum operating pressure, Máxima pressão de exercício	-
Resistencia mecánica (para soportar una chimenea/un conducto de humos), Resistence mécanique (pour soutenir la cheminée), Resistenza mecánica (per supportare il camino), Mechanical strength (to support the fireplace), Resistência mecánica (para suportar a chaminé)	Cumple, Conforme, Conforme, Compliant, Em Conformidade
Potencia térmica ambiente, Puissance rendue au milieu, Potenza resa all'ambiente, Power output to the environment, Potência libertada no ambiente	10.5 kW
Potencia térmica agua, Puissance rendue à l'eau, Potenza ceduta all'acqua, Power transferred to water, Potência cedida à água	-
Rendimiento energético, Rendement, Rendimento, Efficiency, Atuação	80.4 %

	LACUNZA KALOR GROUP S.A.L. Pol. Ind. Ibarrea s/n 31800 Alsasua (Navarra) (Spain)	
	Número, Nombre, Numero, Number, Número : ES-S-011	
Marca, marque, marca, mark, marca: Lacunza Tipo, type, tipo, type, tipo: Estufa, Poêle, Stufa, Stove, Aquecedor Modelo, modèle, modello, model, modelo: CM-300R	Organismo notificado, Laboratoire notifié, Laboratorio notificato, Laboratory notified, Laboratorio notificado: CEIS N° NB1722	
Estufa de carga manual, para quemar combustibles sólidos (indicado en instrucciones), cuya función es calentar el espacio en el que está instalada. Poêle qui se charge manuellement, conçu pour brûler des combustibles solides (indiqués dans le Manuel d'Instructions), dont la fonction est de chauffer l'espace où il est installé. Stufa a carico manuale, per bruciare combustibili solidi (indicati nelle istruzioni), la cui funzione è riscaldare lo spazio in cui è installato. Stove to be loaded by hand and designed to burn solid fuels (indicated in instructions), whose function is to heat the space in which it is installed. Aquecedor de carga manual, para queimar combustíveis sólidos (indicado nas instruções), cuja função é aquecer o espaço no qual está instalado.		
EN13240:2001/A2:2004/AC:2006/AC:2007		
Características esenciales, Caractéristiques essentielles, Caratteristiche essenziali, Essential features, Características essenciais		Prestaciones, Performance, Prestazione, Services, Desempenho
Reacción al fuego, Resistance au feu, Resistenza al fuoco, Resistance to fire, Resistência ao fogo		Cumple, Conforme, Conforme, Compliant, Em Conformidade
Distancia mínima de seguridad a materiales combustibles, Distance minimum aux matériaux combustibles, Distanza minima da materiali combustibili, Minimum distance from combustible material, Distância mínimo de materiais combustíveis		Izquierda, gauche, sinistra, left, esquerda: 200mm Derecha, droite, diritto, right, direito: 200mm Trasera, arrière, retro, back, traseira: 200mm Delantera, avant, fronte, front, frente: 1000mm Encimera, dessus, sopra, above, acima: 750mm
Temperatura humos a potencia térmica nominal, Température des fumées, Temperatura fumi, Fume temperatura, Temperatura dos gases de combustão		286 °C
Emisión productos combustión, Emisión des produits de combustion, Emisión prodotti combustione, Combustión productos emissions, Emissões de produtos de combustão		Cumple, Conforme, Conforme, Compliant, Em Conformidade
Concentración media CO al 13% O2, Concentration moyenne CO al 13% O2, CO concentrazione media di O2%, Average concentration CO to O2%, CO concentração média de O2%		0.31 %
Desprendimiento de sustancias peligrosas, Rejet de substances dangereuses, Rilascio di sostanze pericolose, Release of hazardous substances, Lançamento de substâncias perigosas		Cumple, Conforme, Conforme, Compliant, Em Conformidade
Temperatura superficial, Température de surface, Temperatura superficiale, Surface temperatura, Temperatura superficial		Cumple, Conforme, Conforme, Compliant, Em Conformidade
Seguridad eléctrica, Sécurité électrique, Sicurezza elettrica, Electrical safety, Segurança elétrica		-
Presión máxima de servicio (paila), Pression maximale de service, Máxima pressione di esercizio, Maximum operating pressure, Máxima pressão de exercício		-
Resistencia mecánica (para soportar una chimenea/un conducto de humos), Résistance mécanique (pour soutenir la cheminée), Resistenza mecánica (per supportare il camino), Mechanical strength (to support the fireplace), Resistência mecânica (para suportar a chaminé)		Cumple, Conforme, Conforme, Compliant, Em Conformidade
Potencia térmica ambiente, Puissance rendue au milieu, Potenza resa all'ambiente, Power output to the environment, Potência libertada no ambiente		10.8 kW
Potencia térmica agua, Puissance rendue à l'eau, Potenza ceduta all'acqua, Power transferred to wáter, Potência cedida à água		-
Rendimiento energético, Rendement, Rendimento, Efficiency, Atuação		74 %

	LACUNZA KALOR GROUP S.A.L. Pol. Ind. Ibarrea s/n 31800 Alsasua (Navarra) (Spain)	
	Número, Nombre, Numero, Number, Número : ES-S-012	
Marca, marque, marca, mark, marca: Lacunza Tipo, type, tipo, type, tipo: Estufa, Poêle, Stufa, Stove, Aquecedor Modelo, modèle, modello, model, modelo: CM-300FI y CM-300FD		Organismo notificado, Laboratoire notifié, Laboratorio notificato, Laboratory notified, Laboratorio notificado: CEIS N° NB1722
Estufa de carga manual, para quemar combustibles sólidos (indicado en instrucciones), cuya función es calentar el espacio en el que está instalada. Poêle qui se charge manuellement, conçu pour brûler des combustibles solides (indiqués dans le Manuel d'Instructions), dont la fonction est de chauffer l'espace où il est installé. Stufa a carico manuale, per bruciare combustibili solidi (indicati nelle istruzioni), la cui funzione è riscaldare lo spazio in cui è installato. Stove to be loaded by hand and designed to burn solid fuels (indicated in instructions), whose function is to heat the space in which it is installed. Aquecedor de carga manual, para queimar combustíveis sólidos (indicado nas instruções), cuja função é aquecer o espaço no qual está instalado.		
EN13240:2001/A2:2004/AC:2006/AC:2007		
Características esenciales, Caractéristiques essentielles, Caratteristiche essenziali, Essential features, Características essenciais		Prestaciones, Performance, Prestazione, Services, Desempenho
Reacción al fuego, Resistance au feu, Resistenza al fuoco, Resistance to fire, Resistência ao fogo		Cumple, Conforme, Conforme, Compliant, Em Conformidade
Distancia mínima de seguridad a materiales combustibles, Distance minimum aux matériaux combustibles, Distanza minima da materiali combustibili, Minimum distance from combustible material, Distância mínimo de materiais combustíveis		Izquierda, gauche, sinistra, left, esquerda: 900-200mm Derecha, droite, diritto, right, direito: 900-200mm Trasera, arrière, retro, back, traseira: 400mm Delantera, avant, fronte, front, frente: 1000mm Encimera, dessus, sopra, above, acima: 750mm
Temperatura humos a potencia térmica nominal, Température des fumées, Temperatura fumi, Fume temperatura, Temperatura dos gases de combustão		230 °C
Emisión productos combustión, Emisión des produits de combustion, Emisión prodotti combustione, Combustión productos emissions, Emissões de produtos de combustão		Cumple, Conforme, Conforme, Compliant, Em Conformidade
Concentración media CO al 13% O2, Concentration moyenne CO al 13% O2, CO concentrazione media di O2%, Average concentration CO to O2%, CO concentração média de O2%		0.33 %
Desprendimiento de sustancias peligrosas, Rejet de substances dangereuses, Rilascio di sostanze pericolose, Release of hazardous substances, Lançamento de substâncias perigosas		Cumple, Conforme, Conforme, Compliant, Em Conformidade
Temperatura superficial, Température de surface, Temperatura superficiale, Surface temperatura, Temperatura superficial		Cumple, Conforme, Conforme, Compliant, Em Conformidade
Seguridad eléctrica, Sécurité électrique, Sicurezza elettrica, Electrical safety, Segurança elétrica		-
Presión máxima de servicio (paila), Pression maximale de service, Máxima pressione di esercizio, Maximum operating pressure, Máxima pressão de exercício		-
Resistencia mecánica (para soportar una chimenea/un conducto de humos), Resistence mécanique (pour soutenir la cheminée), Resistenza mecánica (per supportare il camino), Mechanical strength (to support the fireplace), Resistência mecánica (para suportar a chaminé)		Cumple, Conforme, Conforme, Compliant, Em Conformidade
Potencia térmica ambiente, Puissance rendue au milieu, Potenza resa all'ambiente, Power output to the environment, Potência libertada no ambiente		10.8 kW
Potencia térmica agua, Puissance rendue à l'eau, Potenza ceduta all'acqua, Power transferred to water, Potência cedida à água		-
Rendimiento energético, Rendement, Rendimento, Efficiency, Atuação		79.3 %

LACUNZA KALOR GROUP S.A.L
Pol. Ind. Ibarrea s/n
31800 Alsasua (Navarra) Spain
Tel.: (00 34) 948 56 35 11
Fax.: (00 34) 948 56 35 05
e-mail: comercial@lacunza.net
Website: www.lacunza.net
EDITION: 0

